

Safety Instructions

1, 2, 3, 4, 5, 6, 7, 10, 11,
12, 13, 14, 15, 16, 17, 18,
20, 21, 22, 24, 28, 33, 34,



Info Hotline



+49 (0) 5041 998 389

Mon. - Do. 7⁰⁰ - 20⁰⁰
Fr. 7⁰⁰ - 17⁰⁰

Paulmann Licht GmbH
Quezinger Feld 2
31832 Springe /
Germany

www.paulmann.com

Art.-Nr.:708.83
(+MA 326)PUP 12/16

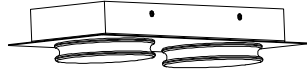

6mm



6mm

A



Safety Instructions
Nr.5

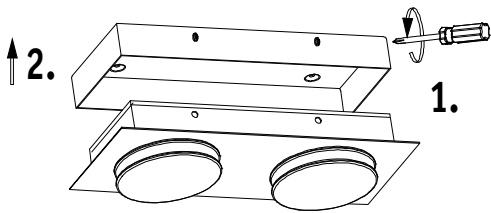

B

Safety Instructions
Nr. 1,2,4,5,7

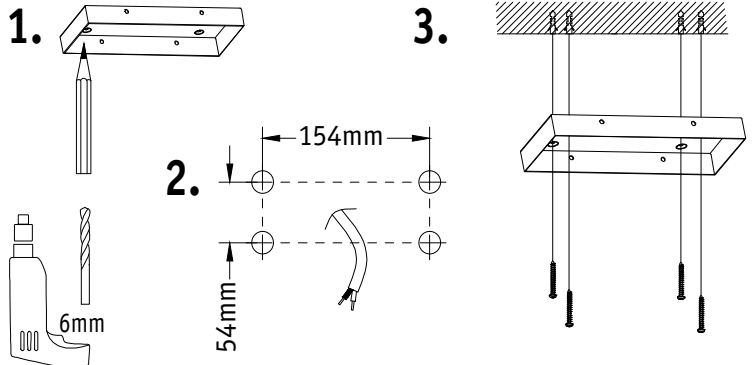

C

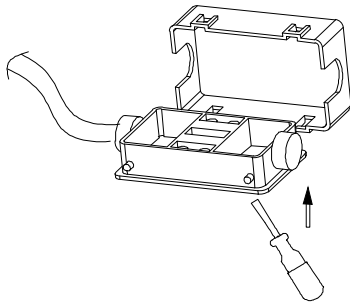

D

Safety Instructions
Nr. 1,2,3,4,5

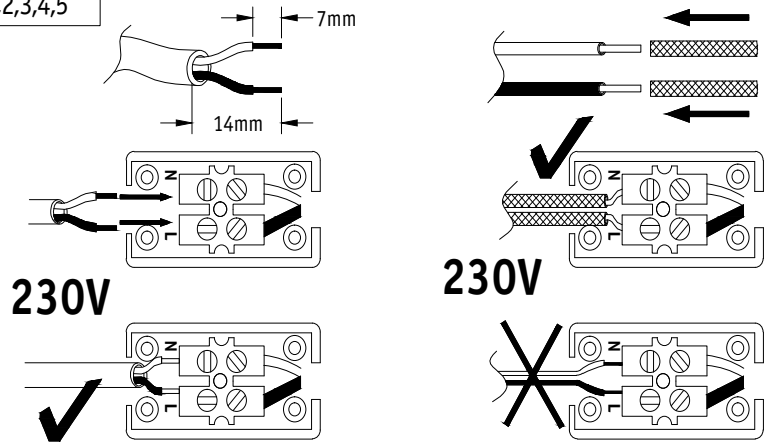

E

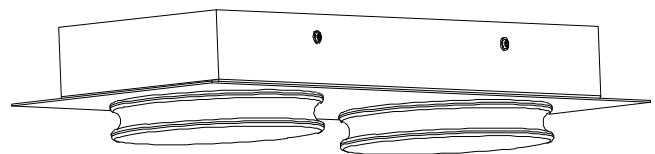
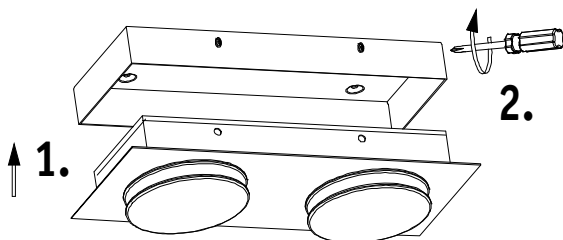

IP23